

Profilmesser 50 x 4 mm

Qualität: SP-Stahl und HS

Abweiser A 48 x 4 mm

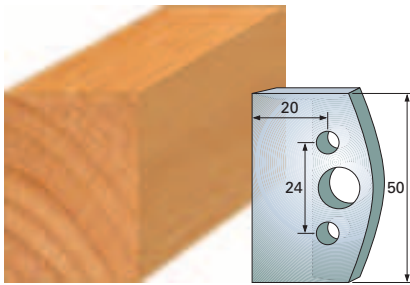

F 500 SP
F 5500 HS
A 500

Profile knives 50 x 4 mm

Quality: SP steel and HS

Limiter A 48 x 4 mm

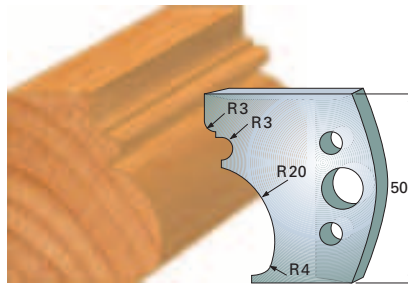

F 501 SP
F 5501 HS
A 501

Couteaux profilés 50 x 4 mm

Qualité: Acier SP et HS

Contre-fer A 48 x 4 mm

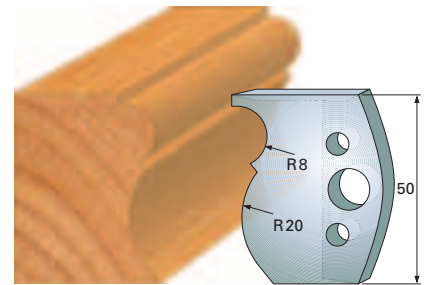

F 502 SP
F 5502 HS
A 502

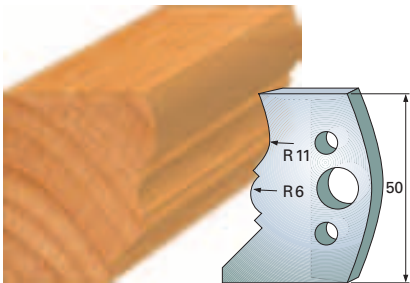

F 503 SP
F 5503 HS
A 503

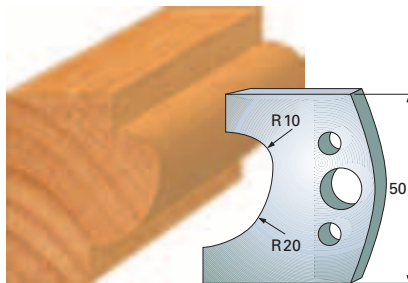

F 504 SP
F 5504 HS
A 504

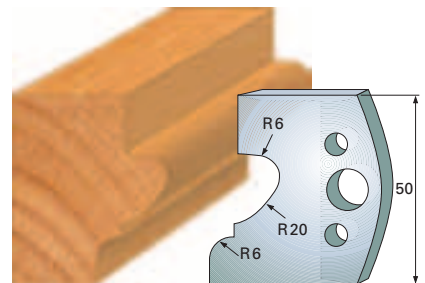

F 505 SP
F 5505 HS
A 505

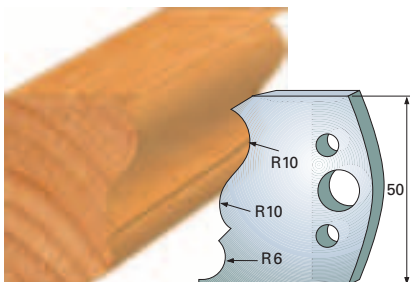

F 506 SP
F 5506 HS
A 506

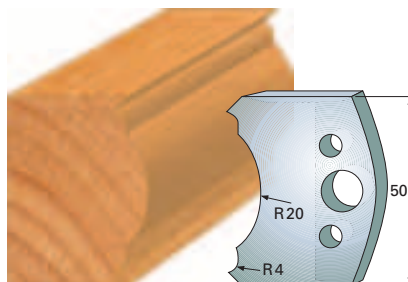

F 507 SP
F 5507 HS
A 507

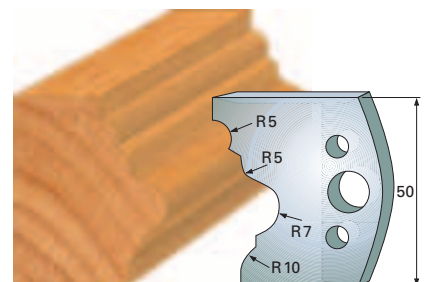

F 508 SP
F 5508 HS
A 508

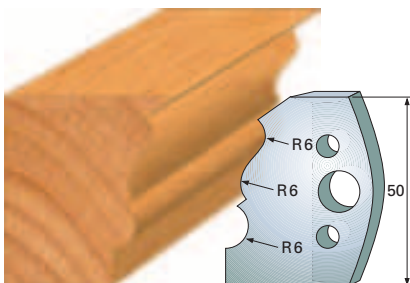

F 509 SP
F 5509 HS
A 509

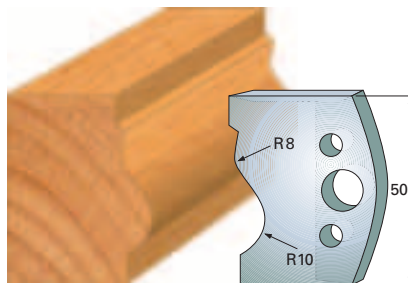

F 510 SP
F 5510 HS
A 510

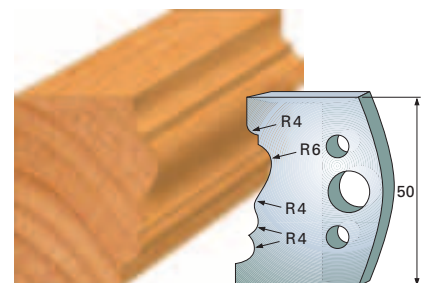

F 511 SP
F 5511 HS
A 511

Preise pro Stück / prices per piece / prix par pièce

Profilmesser 50 x 4 mm

Qualität: SP-Stahl und HS

Abweiser A 48 x 4 mm

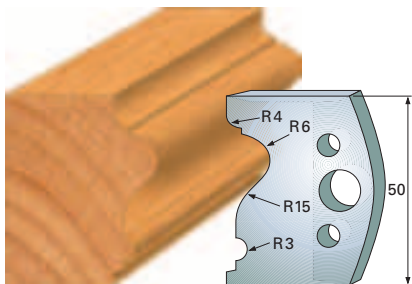

F 512 SP
F 5512 HS
A 512

Profile knives 50 x 4 mm

Quality: SP steel and HS

Limiter A 48 x 4 mm

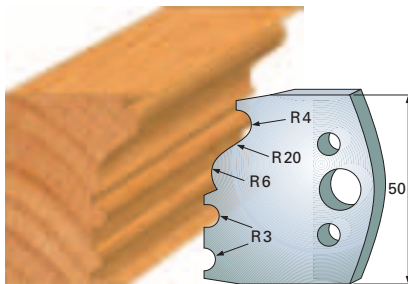

F 513 SP
F 5513 HS
A 513

Couteaux profilés 50 x 4 mm

Qualité: Acier SP et HS

Contre-fer A 48 x 4 mm

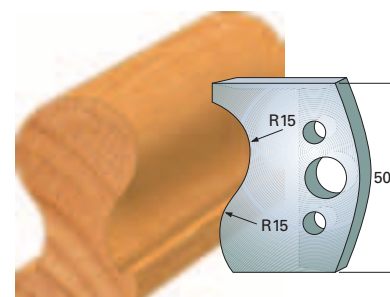

F 514 SP
F 5514 HS
A 514

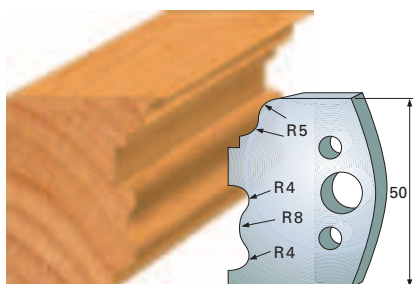

F 515 SP
F 5515 HS
A 515

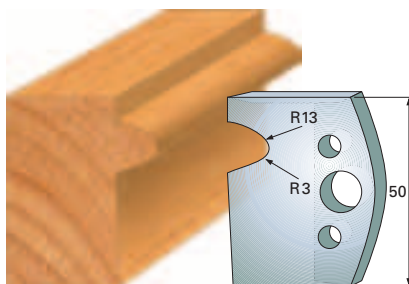

F 516 SP
F 5516 HS
A 516

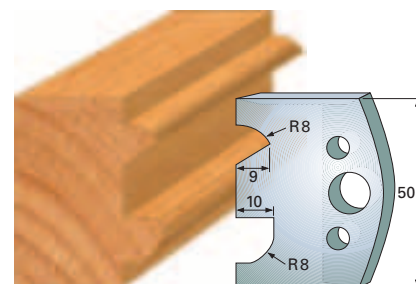

F 517 SP
F 5517 HS
A 517

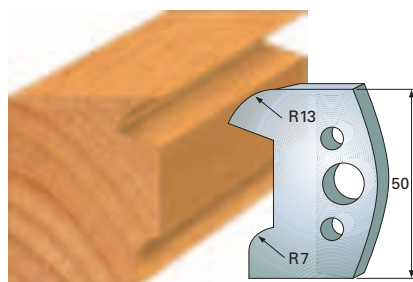

F 518 SP
F 5518 HS
A 518

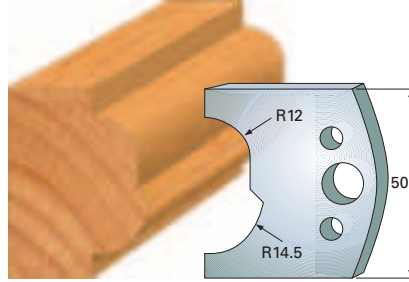

F 519 SP
F 5519 HS
A 519

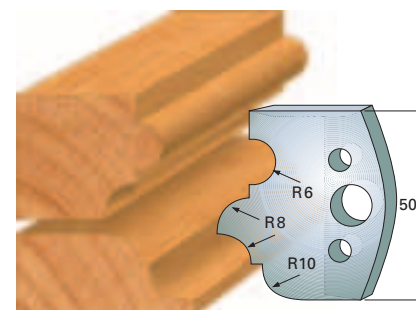

F 520 SP
F 5520 HS
A 520

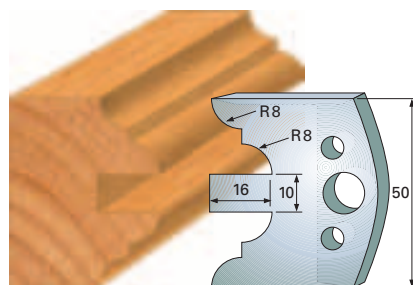

F 522 SP
F 5522 HS
A 522

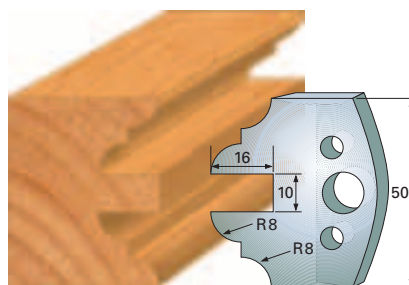

F 523 SP
F 5523 HS
A 523

Profilmesser 50 x 4 mm

Qualität: SP-Stahl und HS

Abweiser A 48 x 4 mm

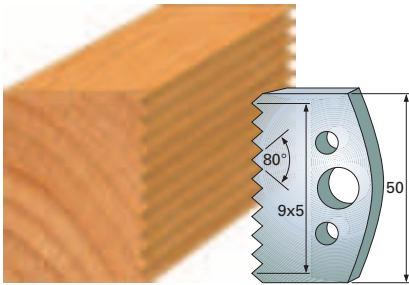

F 524 SP
F 5524 HS
A 524

Profile knives 50 x 4 mm

Quality: SP steel and HS

Limiter A 48 x 4 mm

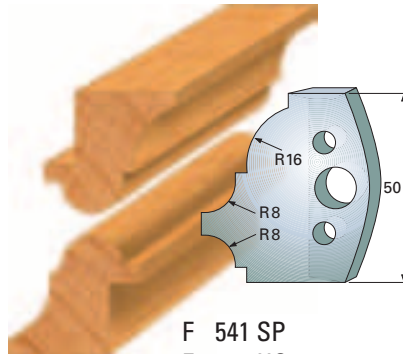

F 541 SP
F 5541 HS
A 541

Couteaux profilés 50 x 4 mm

Qualité: Acier SP et HS

Contre-fer A 48 x 4 mm

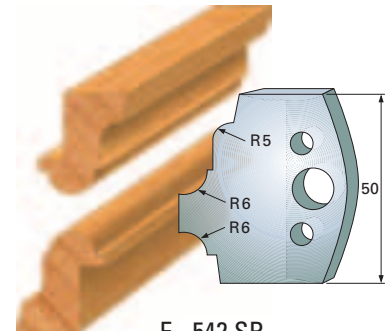

F 542 SP
F 5542 HS
A 542

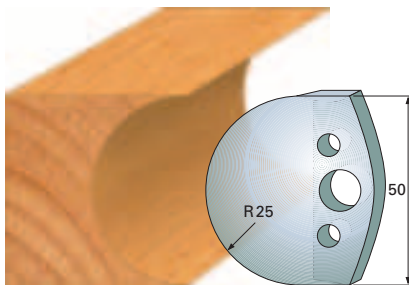

F 543 SP
F 5543 HS
A 543

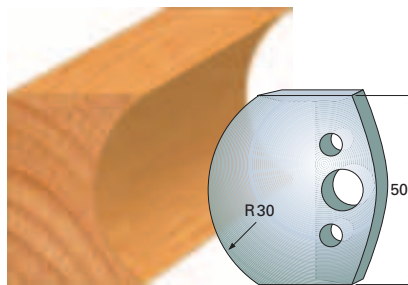

F 544 SP
F 5544 HS
A 544

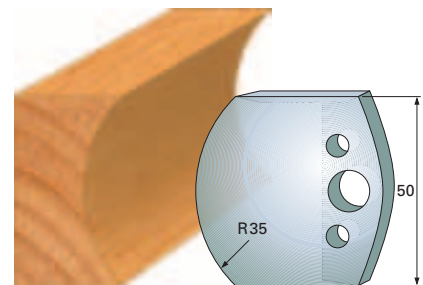

F 545 SP
F 5545 HS
A 545

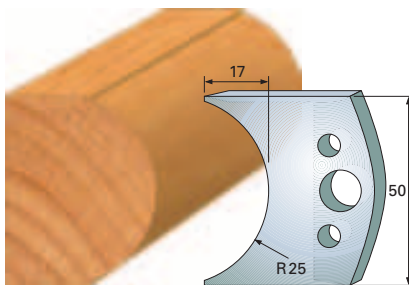

F 546 SP
F 5546 HS
A 546

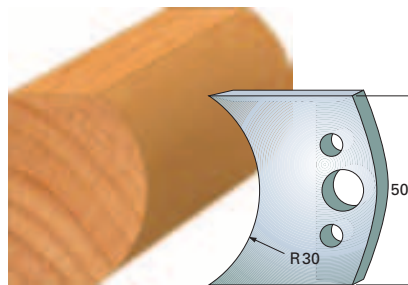

F 547 SP
F 5547 HS
A 547

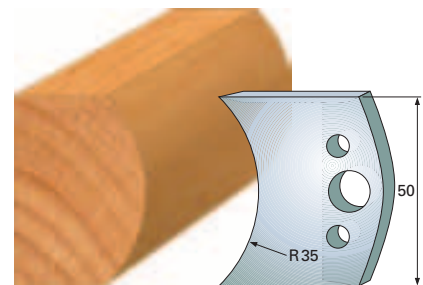

F 548 SP
F 5548 HS
A 548

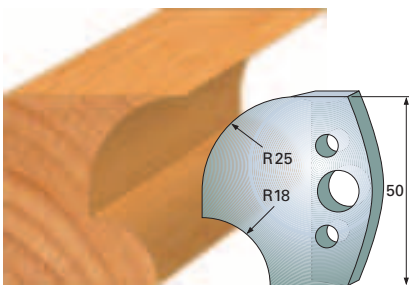

F 549 SP
F 5549 HS
A 549

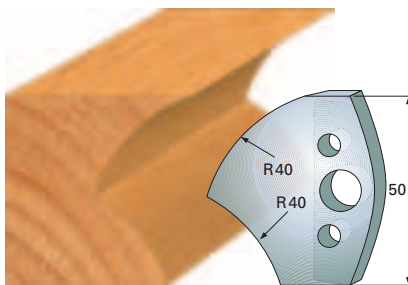

F 550 SP
F 5550 HS
A 550

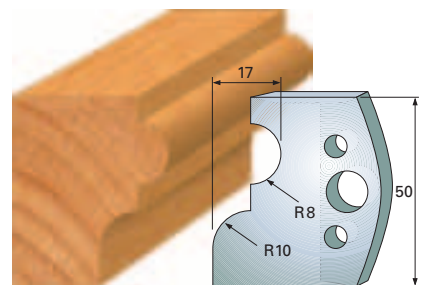

F 551 SP
F 5551 HS
A 551

Preise pro Stück / prices per piece / prix par pièce

Profilmesser 50 x 4 mm

Qualität: SP-Stahl und HS

Abweiser A 48 x 4 mm

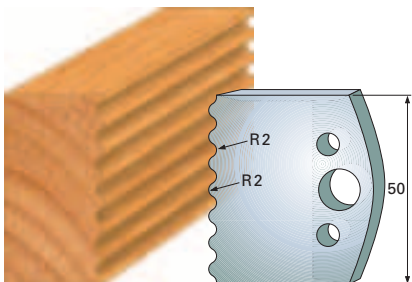

F 552 SP
F 5552 HS
A 552

Profile knives 50 x 4 mm

Quality: SP steel and HS

Limiter A 48 x 4 mm

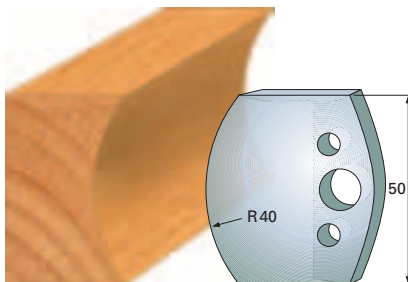

F 553 SP
F 5553 HS
A 553

Couteaux profilés 50 x 4 mm

Qualité: Acier SP et HS

Contre-fer A 48 x 4 mm

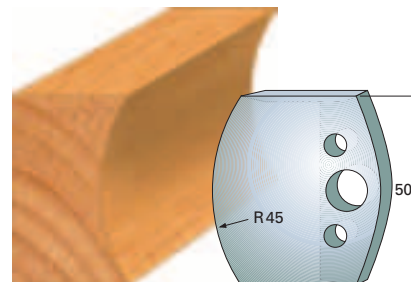

F 554 SP
F 5554 HS
A 554

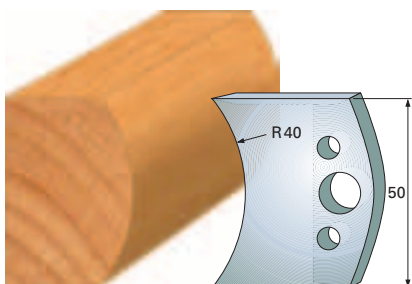

F 555 SP
F 5555 HS
A 555

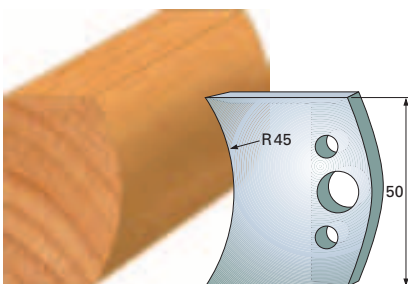

F 556 SP
F 5556 HS
A 556

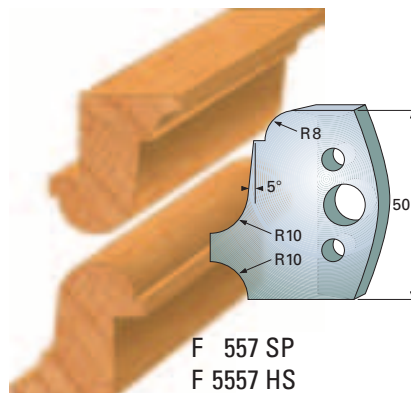

F 557 SP
F 5557 HS
A 557

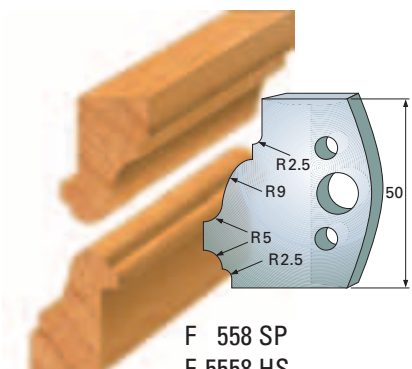

F 558 SP
F 5558 HS
A 558

Profilmesser 50 x 4 mm

Qualität: SP-Stahl und HS

Abweiser A 48 x 4 mm

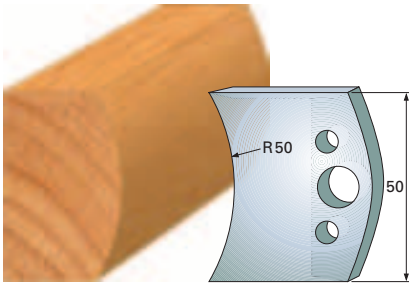

F 559 SP
F 5559 HS
A 559

Profile knives 50 x 4 mm

Quality: SP steel and HS

Limiter A 48 x 4 mm

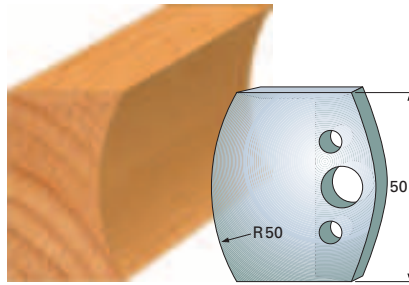

F 560 SP
F 5560 HS
A 560

Couteaux profilés 50 x 4 mm

Qualité: Acier SP et HS

Contre-fer A 48 x 4 mm

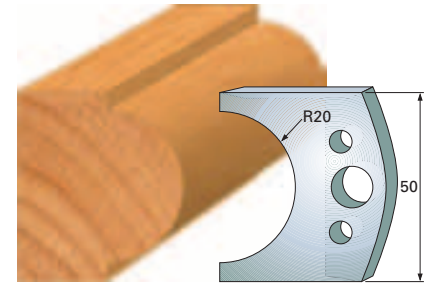

F 561 SP
F 5561 HS
A 561

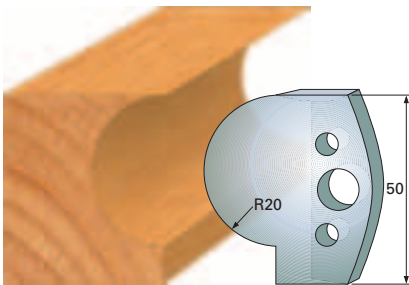

F 562 SP
F 5562 HS
A 562

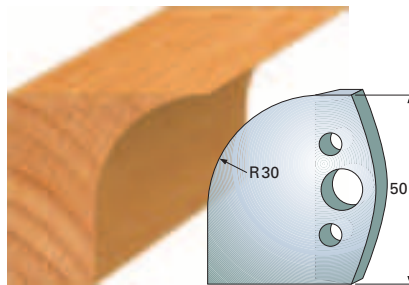

F 563 SP
F 5563 HS
A 563

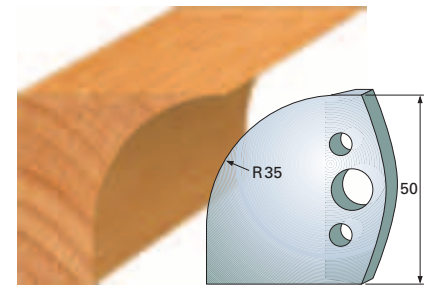

F 564 SP
F 5564 HS
A 564

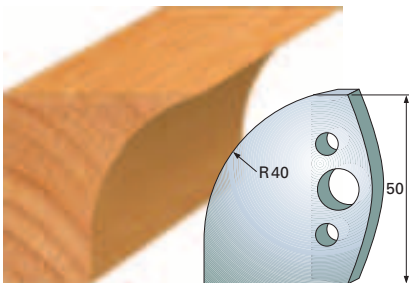

F 565 SP
F 5565 HS
A 565

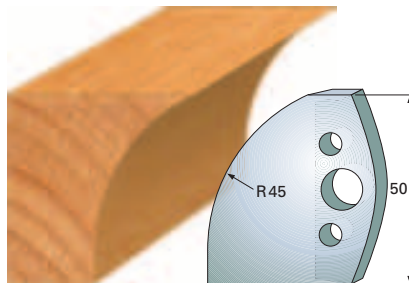

F 566 SP
F 5566 HS
A 566

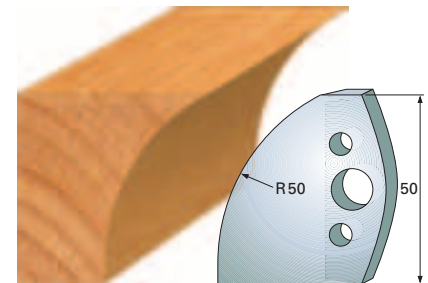

F 567 SP
F 5567 HS
A 567

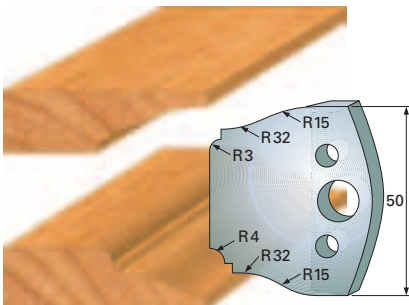

F 568 SP
F 5568 HS
A 568

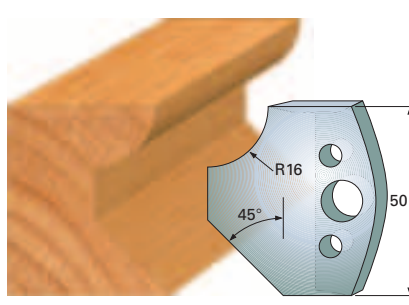

F 569 SP
F 5569 HS
A 569

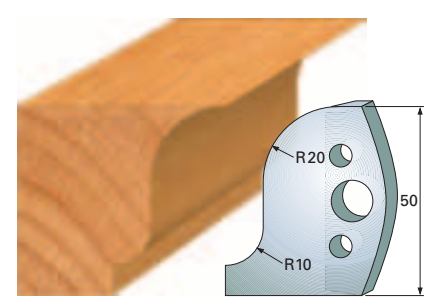

F 570 SP
F 5570 HS
A 570

Preise pro Stück / prices per piece / prix par pièce

Profilmesser 50 x 4 mm

Qualität: SP-Stahl und HS

Abweiser A 48 x 4 mm

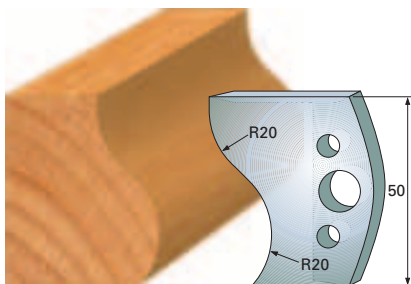

F 571 SP
F 5571 HS
A 571

Profile knives 50 x 4 mm

Quality: SP steel and HS

Limiter A 48 x 4 mm

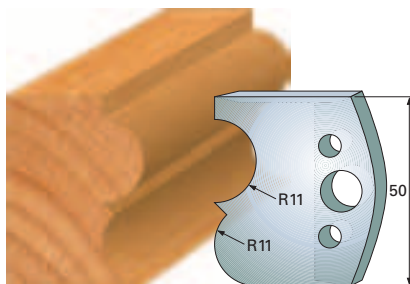

F 572 SP
F 5572 HS
A 572

Couteaux profilés 50 x 4 mm

Qualité: Acier SP et HS

Contre-fer A 48 x 4 mm

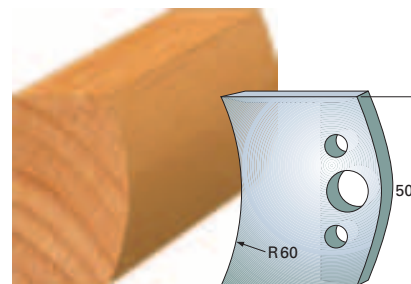

F 573 SP
F 5573 HS
A 573

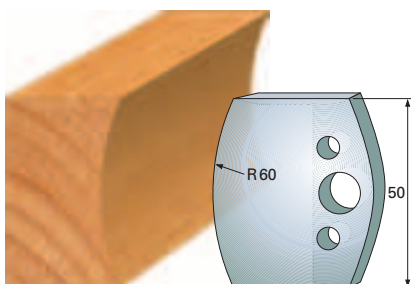

F 574 SP
F 5574 HS
A 574

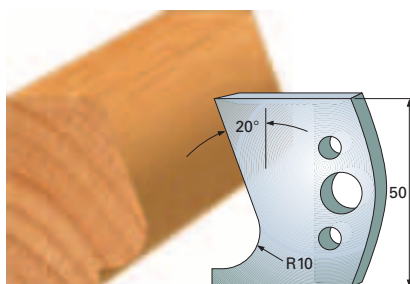

F 575 SP
F 5575 HS
A 575

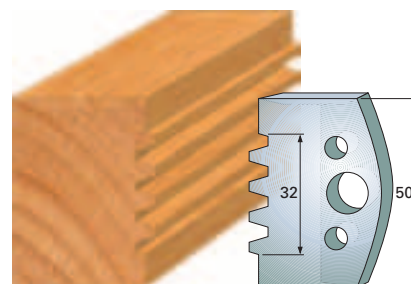

F 576 SP
F 5576 HS
A 576

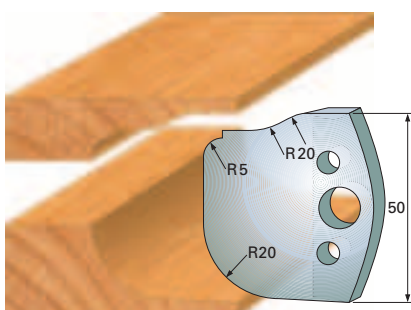

F 577 SP
F 5577 HS
A 577

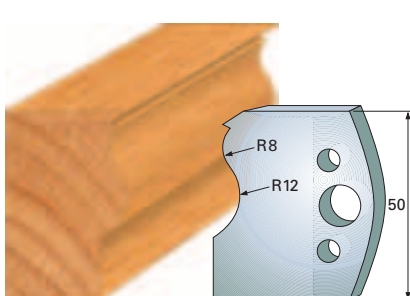

F 578 SP
F 5578 HS
A 578

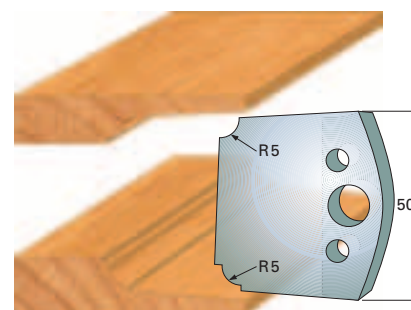

F 579 SP
F 5579 HS
A 579

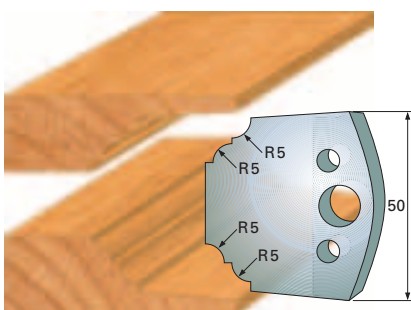

F 580 SP
F 5580 HS
A 580

Preise pro Stück / prices per piece / prix par pièce

Messerblanketten 50 x 4 mm

Qualität: SP-Stahl und HS

Abweiser A 48 x 4 mm

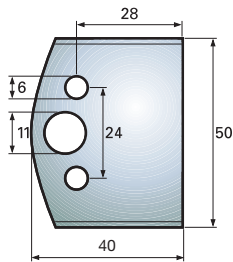

F 598 SP
F 5196 HS
A 598

Max. Profilierungstiefe 14 mm
Profiling depth max. 14 mm
Zone de profilage max. 14 mm

Blank knives 50 x 4 mm

Quality: SP steel and HS

Limiter A 48 x 4 mm

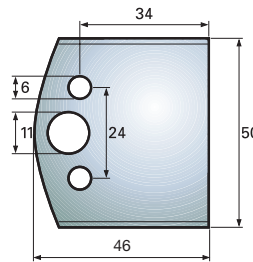

F 599 SP
F 5194 HS
A 599

Max. Profilierungstiefe 20 mm
Profiling depth max. 20 mm
Zone de profilage max. 20 mm

Couteaux bruts 50 x 4 mm

Qualité: Acier SP et HS

Contre-fer A 48 x 4 mm

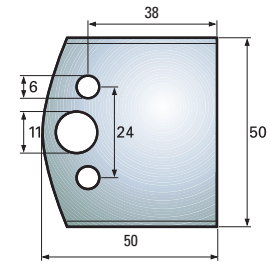

F 5199 HS
A 5199

Max. Profilierungstiefe 24 mm
Profiling depth max. 24 mm
Zone de profilage max. 24 mm